

Alpha Bridge AQS28-F-30-AK Datasheet





Features

- QSFP MSA compliant
- Four independent full-duplex channels
- Supports 103.1Gb/s aggregate bit rate
- Up to 100m OM4 MMF transmission
- Operating case temperature: 0 to 70°C
- 4x25G electrical interface (OIF CEI-28G-VSR)
- Single 3.3V power supply
- Maximum power consumption 2.5W each terminal
- RoHS-6 compliant

Application

- 100G Ethernet
- Infiniband EDR

Absolute Maximum Ratings

Parameter	Symbol	Min.	Max.	Units	Note
Storage Temperature	<i>T_S</i>	-40	85	°C	
Operating Case Temperature	<i>T_{op}</i>	0	70	°C	
Power Supply Voltage	<i>V_{cc}</i>	-0.5	3.6	V	
Relative Humidity (non-condensation)	<i>RH</i>	0	85	%	

Recommended Operating Conditions

Parameter	Symbol	Min.	Typical	Max.	Units	Note
Operating Case Temperature	<i>T_{op}</i>	0		70	°C	
Power Supply Voltage	<i>V_{cc}</i>	3.135	3.3	3.465	V	
Data Rate, each Lane			25.78125	28.05	Gb/s	
Control Input Voltage High		2		<i>V_{cc}</i>	V	
Control Input Voltage Low		0		0.8	V	

AOC Block Diagram

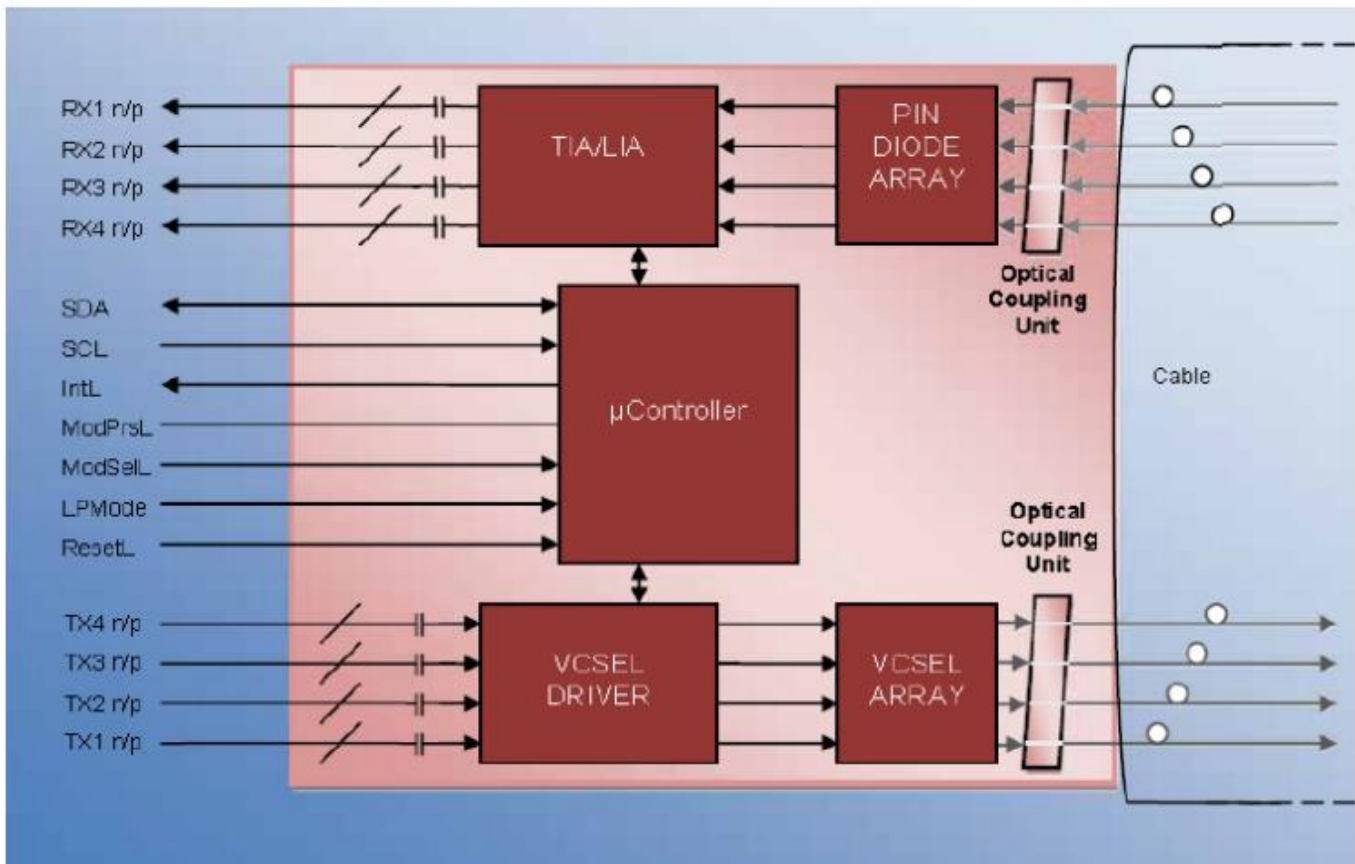

Block Diagram of One of the QSFP28 End Modules

Electrical Characteristics-Transmitter (each Lane)

Parameter	Symbol	Min	Type	Max	Units	Notes
Power Consumption				2.5	W	1
Supply Current	I _{cc}			757	mA	1
Overload Differential Voltage pk-pk	TP1a	900			mV	
Common Mode Voltage (V _{cm})	TP1	-350		2850	mV	2
Differential Termination Resistance Mismatch	TP1			10	%	At 1MHz
Differential Return Loss (SDD11)	TP1	See CEI-28G-VSR Section 13-19			dB	
Common Mode to Differential conversion and Differential to common Mode Conversion (SDC11, SCD11)	TP1	See CEI-28G-VSR Section 13-20			dB	
Stressed Input Test	TP1a	See CEI-28G-VSR Section 13.3.11.2.1				

Note:

1. Per terminal.
2. V_{cm} is generated by the host. Specification includes effects of ground offset voltage.

Electrical Characteristics-Receiver (each Lane)

Parameter	Symbol	Min	Type	Max	Units	Notes
Differential Voltage, pk-pk	TP4			900	mV	
Common Mode Voltage (Vcm)	TP4	-350		2850	mV	1
Common Mode Noise, RMS	TP4			17.5	mV	
Differential Termination Resistance Mismatch	TP4			10	%	At 1MHz
Differential Return Loss (SDD22)	TP4			See CEI-28G-VSR Section 13-19	dB	
Common Mode to Differential conversion and Differential to common Mode Conversion (SDC22, SCD22)	TP4			See CEI-28G-VSR Section 13-21	dB	
Common Mode Return Loss (SCC22)	TP4			-2	dB	2
Transition Time, 20 to 80%	TP4	9.5			Ps	
Vertical Eye Closure (VEC)	TP4			5.5	dB	
Eye Width at 10-15 probability (EW15)	TP4	0.57			UI	
Eye Height at 10-15 probability (EH15)	TP4	228			mV	

Note:

1. Vcm is generated by the host. Specification includes effects of ground offset voltage.
2. From 250MHz to 30GHz.

Pin Assignment

QSFP Module Pad Layout (Top View)

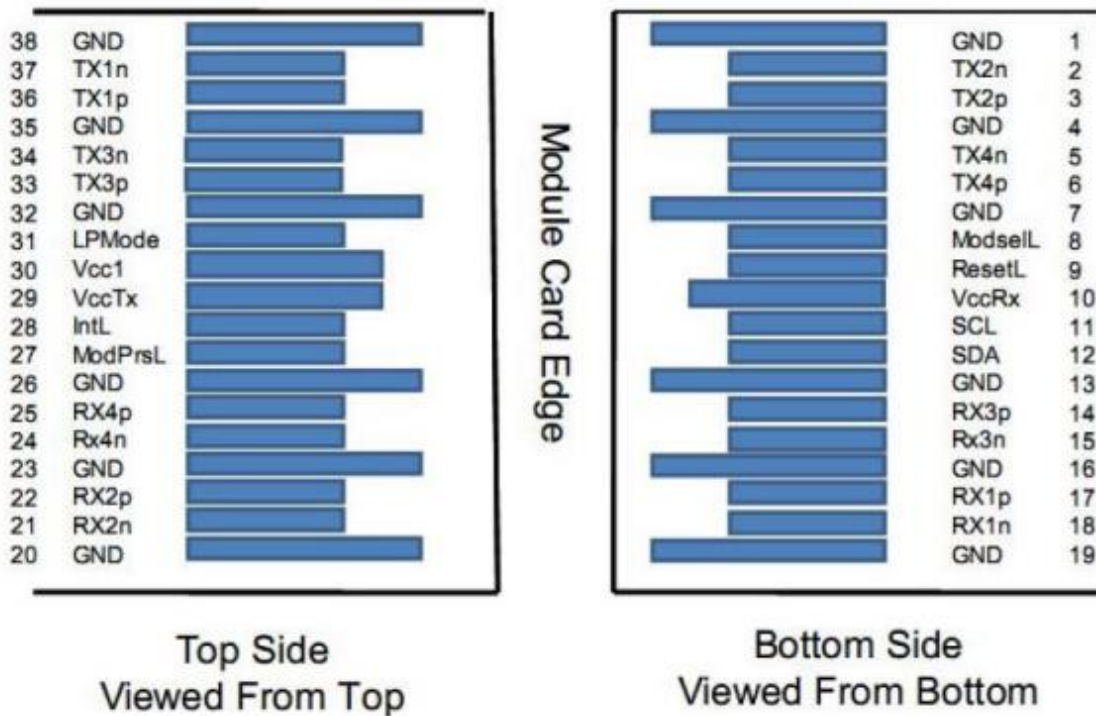

Pin Definition

Pin	Logic	Symbol	Description	Notes
1		GND	Ground	1
2	CML-I	Tx2n	Transmitter Inverted Data Input	
3	CML-I	Tx2p	Transmitter Non-inverted Data Input	
4		GND	Ground	1
5	CML-I	Tx4n	Transmitter Inverted Data Input	
6	CML-I	Tx4p	Transmitter Non-inverted Data Input	
7		GND	Ground	1
8	LVTTTL-I	ModSelL	Module Select	
9	LVTTTL-I	ResetL	Module Reset	
10		VccRx	+3.3V Power Supply Receiver	2
11	LVCNOS-I/O	SCL	2-Wire Serial Interface Clock	
12	LVCNOS-I/O	SDA	2-Wire Serial Interface Data	
13		GND	Ground	
14	CML-O	Rx3p	Receiver Non-Inverted Data Output	
15	CML-O	Rx3n	Receiver Inverted Data Output	
16		GND	Ground	1
17	CML-O	Rx1p	Receiver Non-Inverted Data Output	
18	CML-O	Rx1n	Receiver Inverted Data Output	
19		GND	Ground	1
20		GND	Ground	1
21	CML-O	Rx2n	Receiver Inverted Data Output	
22	CML-O	Rx2p	Receiver Non-Inverted Data Output	
23		GND	Ground	1
24	CML-O	Rx4n	Receiver Inverted Data Output	
25	CML-O	Rx4p	Receiver Non-Inverted Data Output	
26		GND	Ground	1
27	LVTTTL-O	ModPrsL	Module Present	
28	LVTTTL-O	IntL	Interrupt	
29		VccTx	+3.3V Power Supply Transmitter	2
30		Vcc1	+3.3V Power Supply	2
31	LVTTTL-1	LPMODE	Low Power Mode	
32		GND	Ground	1
33	CML-I	Tx3p	Transmitter Non-Inverted Data Input	
34	CML-I	Tx3n	Transmitter Inverted Data Input	
35		GND	Ground	1
36	CML-I	Tx1p	Transmitter Non-Inverted Data Input	
37	CML-I	Tx1n	Transmitter Inverted Data Input	

38		GND	Ground	1
----	--	-----	--------	---

- Note:
- GND is the symbol for signal and supply (power) common for QSFP28 modules. All are common within the QSFP28 module and all module voltages are referenced to this potential unless otherwise noted. Connect these directly to the host board signal common ground plane.
 - VccRx, Vcc1 and VccTx are the receiving and transmission power suppliers and shall be applied concurrently. Recommended host board power supply filtering is shown in Figure 3 below. Vcc Rx, Vcc1 and Vcc Tx may be internally connected within the QSFP28 transceiver module in any combination. The connector pins are each rated for a maximum current of 1000mA.

Dimensions

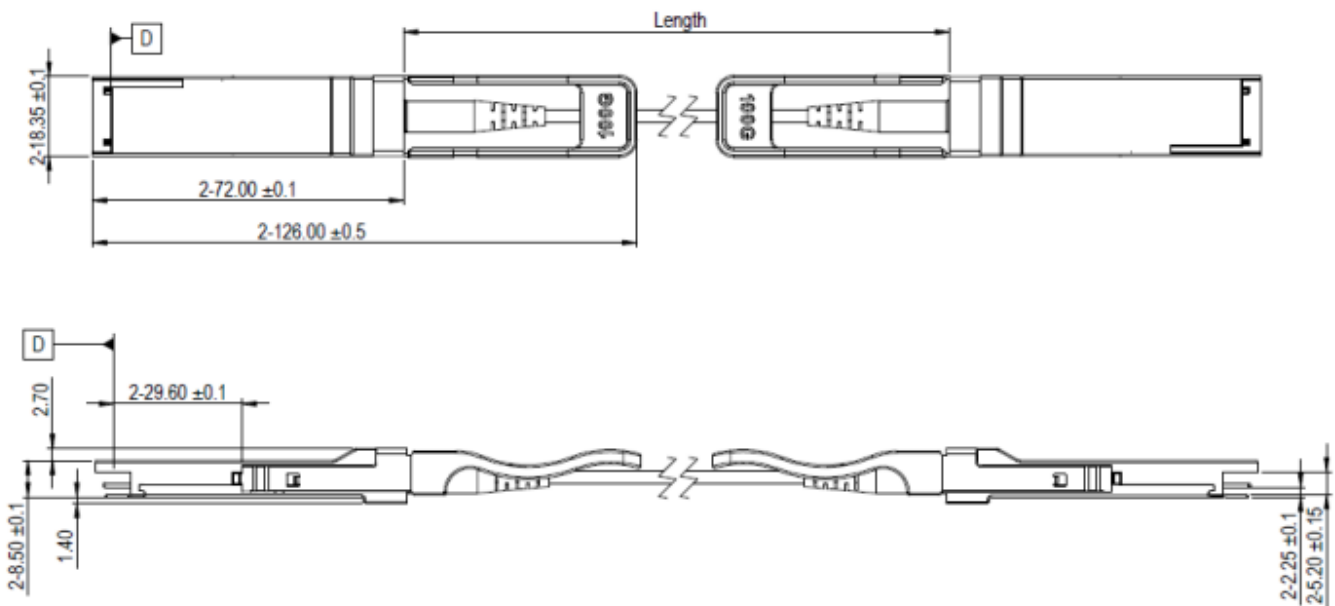

Ordering Information

Part Number	Model Number	Length (M)	Voltage	Temperature
AQS28-F-30-AK	Active Optical Cable	3	3.3V	0°C to 70°C

Note: All information contained in this document is subject to change without notice.