

Alpha Bridge ASF28-F-20-AK Datasheet





Features

- Transmission data rate up to 25.78Gbps
- 850nm VCSEL laser
- PIN photo-detector
- Internal CDR on both transmitter and receiver channels
- Hot-pluggable SFP28 form factor
- Up to 70m on OM3 MMF and 100m on OM4 MMF
- Digital diagnostics functions are available (optional)
- Operating case temperature range 0°C to +70°C
- 3.3V power supply voltage
- RoHS-6 compliant

Applications

- IEEE 802.3by 25GBASE-SR

Absolute Maximum Ratings

Parameter	Symbol	Min.	Max.	Units	Note
Supply Voltage	<i>V_{cc}</i>	0	3.6	V	
Storage Temperature	<i>T_S</i>	-40	85	°C	
Case Operating Temperature	<i>T_c</i>	0	70	°C	
Relative Humidity	<i>RH</i>	5	85	%	1

Recommended Operating Conditions

Parameter	Symbol	Min.	Typical	Max.	Units	Note
Supply Voltage	<i>V_{cc}</i>	3.13	3.3	3.47	V	
Supply Current	<i>I_{cc}</i>			300	mA	
Fiber Length on 50/125µm high-bandwidth (OM3) MMF				70	m	
Fiber Length on 50/125µm high-bandwidth (OM4) MMF				100	m	

Diagnostics Specification

Parameter	Range	Units	Accuracy	Calibration
Temperature	0 to +70	°C	±3°C	Internal / External
Voltage	3.0 to 3.6	V	±3%	Internal / External
Bias Current	0 to 20	mA	±10%	Internal / External
TX Power	-8 to 3	dBm	±3dB	Internal / External
RX Power	-14 to 0	dBm	±3dB	Internal / External

Transmitter Electro-optical Characteristics

V_{cc} = 3.13 V to 3.47 V, TC = 0°C to 70°C

Parameter	Symbol	Min	Type	Max	Units	Notes
Data Rate	BR		25.78		Gbps	
Centre Wavelength	λ_c	840	1310	860	nm	
Spectral Width (-20dB)	σ			0.6	nm	
Average Output Power	P _{avg}	-8.4		2.4	dB	
Optical Power OMA	P _{OMA}	-6.4		3	dBm	
Extinction Ratio	ER	2			dB	
Differential data input swing	V _{IN,PP}	40		1000	mV	
Input Differential Impedance	Z _{IN}	90	100	110	Ω	
TX Disable	Disable	2.0		V _{cc}	V	
	Enable	0		0.8	V	
TX Fault	Fault	2.0		V _{cc}	V	
	Normal	0		0.8	V	

Receiver Electro-optical Characteristics

V_{cc} = 3.13 V to 3.47 V, TC = 0°C to 70°C

Parameter	Symbol	Min	Type	Max	Units	Notes
Data rate	BR		25.78		Gbps	
Centre Wavelength	λ_c	840	850	860	nm	
Receiver Sensitivity (OMA)	P _{sens}			-10	dBm	
Stressed Sensitivity (OMA)				-5.2	dBm	
Receiver Power (OMA)				3	dBm	
LOS De-Assert	LOS _D			-13	dBm	
LOS Assert	LOS _A	-30			dBm	
LOS Hysteresis		0.5			dB	
Differential data output swing	V _{out,PP}	300		850	mV	
LOS	High	2.0		V _{cc}	V	
	Low			0.8	V	

Note:

1. Receive Sensitivity measured with a prbs31 pattern @25.78125Gb/s, BER 1E-5;

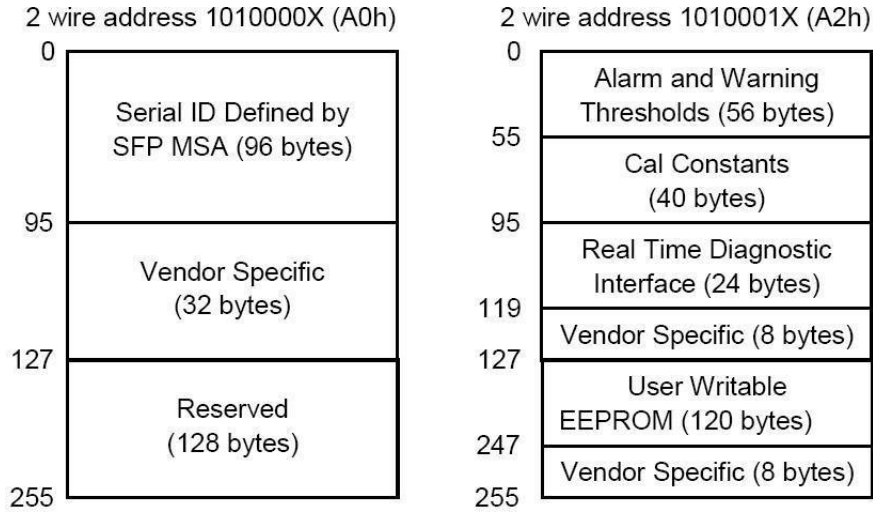

Recommended Interface Circuit

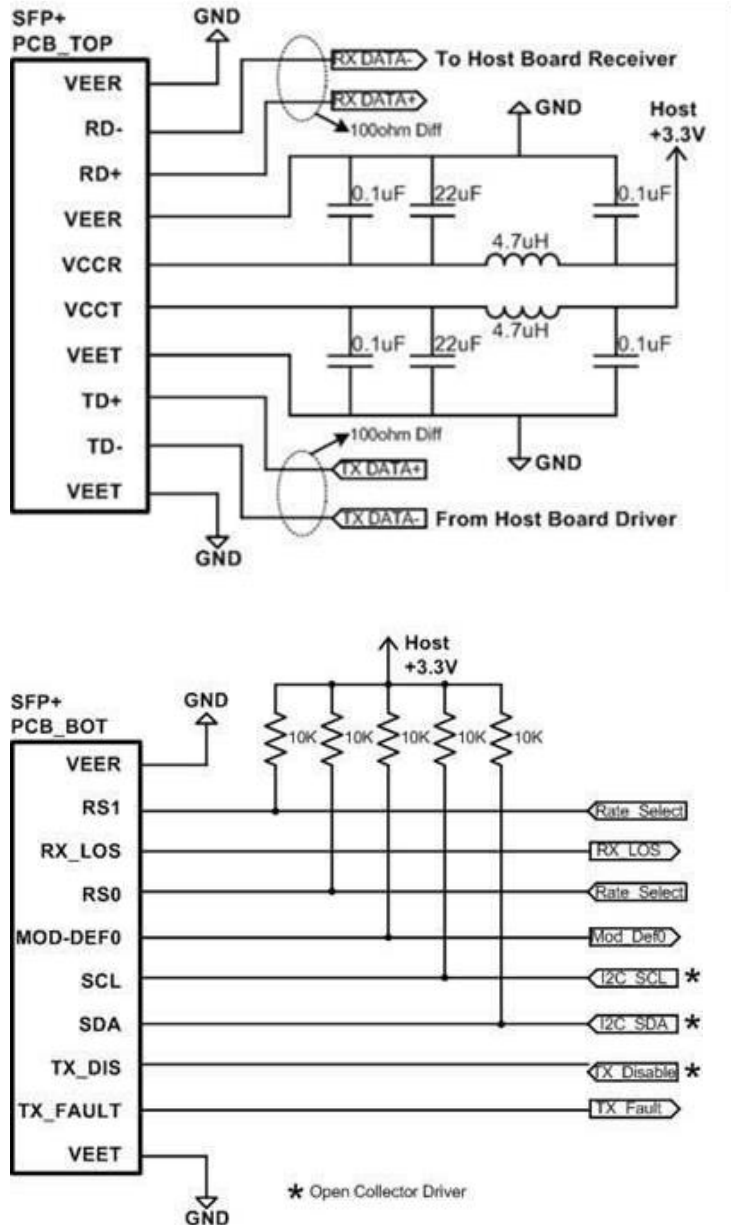

Pin Assignment

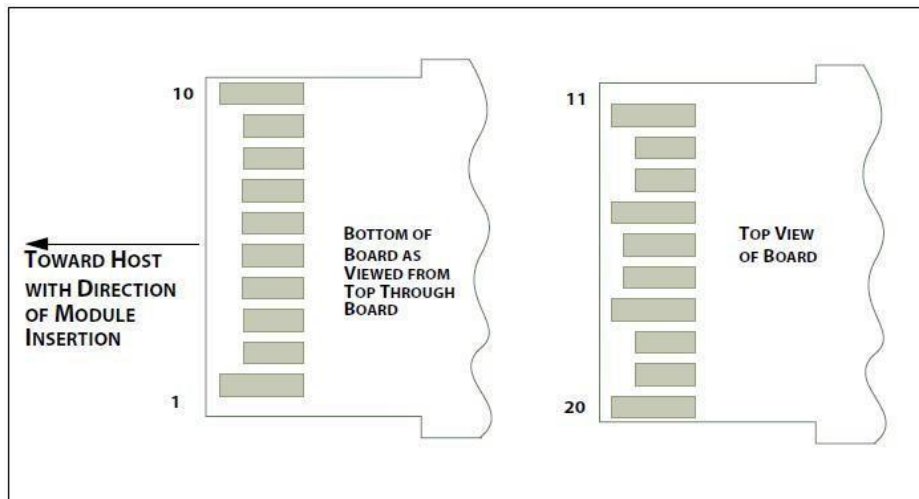
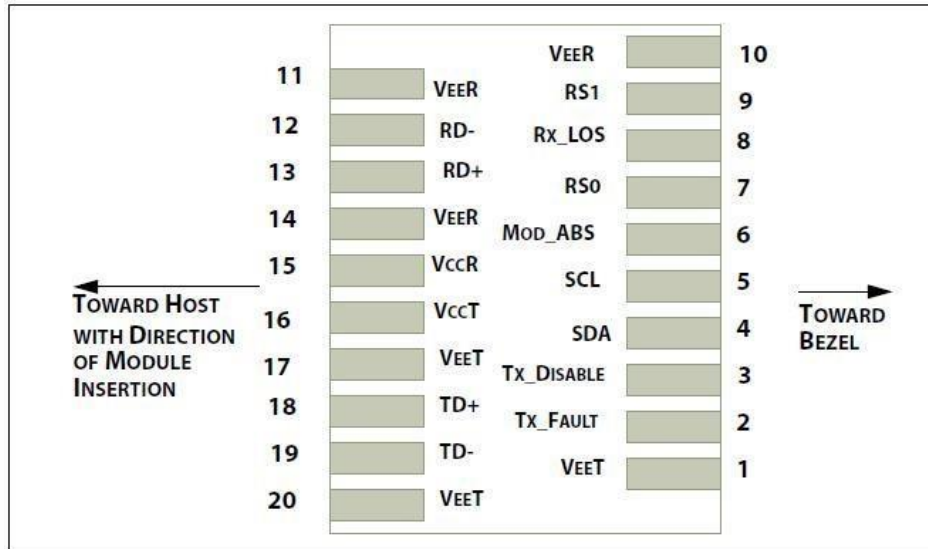

Pin Descriptions

Pin	Logic	Symbol	Name/Description	Note
1		VeeT	Module Transmitter Ground	1
2	LVTTTL-O	TX_Fault	Module Transmitter Fault	2
3	LVTTTL-I	TX_Dis	Transmitter Disable; Turns off transmitter laser output	
4	LVTTTL-I/O	SDA	2-Wire Serial Interface Data Line	2
5	LVTTTL-I	SCL	2-Wire Serial Interface Clock	2
6		MOD_ABS	Module Definition, Grounded in the module	
7	LVTTTL-I	RS0	Receiver Rate Select	
8	LVTTTL-O	RX_LOS	Receiver Loss of Signal Indication Active LOW	
9	LVTTTL-I	RS1	Transmitter Rate Select (not used)	
10		VeeR	Module Receiver Ground	1
11		VeeR	Module Receiver Ground	1
12	CML-O	RD-	Receiver Inverted Data Output	

13	CML-O	RD+	Receiver Data Output	
14		VeeR	Module Receiver Ground	1
15		VccR	Module Receiver 3.3 V Supply	
16		VccT	Module Receiver 3.3 V Supply	
17		VeeT	Module Transmitter Ground	1
18	CML-I	TD+	Transmitter Non-Inverted Data Input	
19	CML-I	TD-	Transmitter Inverted Data Input	
20		VeeT	Module Transmitter Ground	1

Note:

1. Module ground pins GND are isolated from the module case.
2. Shall be pulled up with 4.7K-10Kohms to a voltage between 3.15V and 3.45V on the host board.

Dimensions

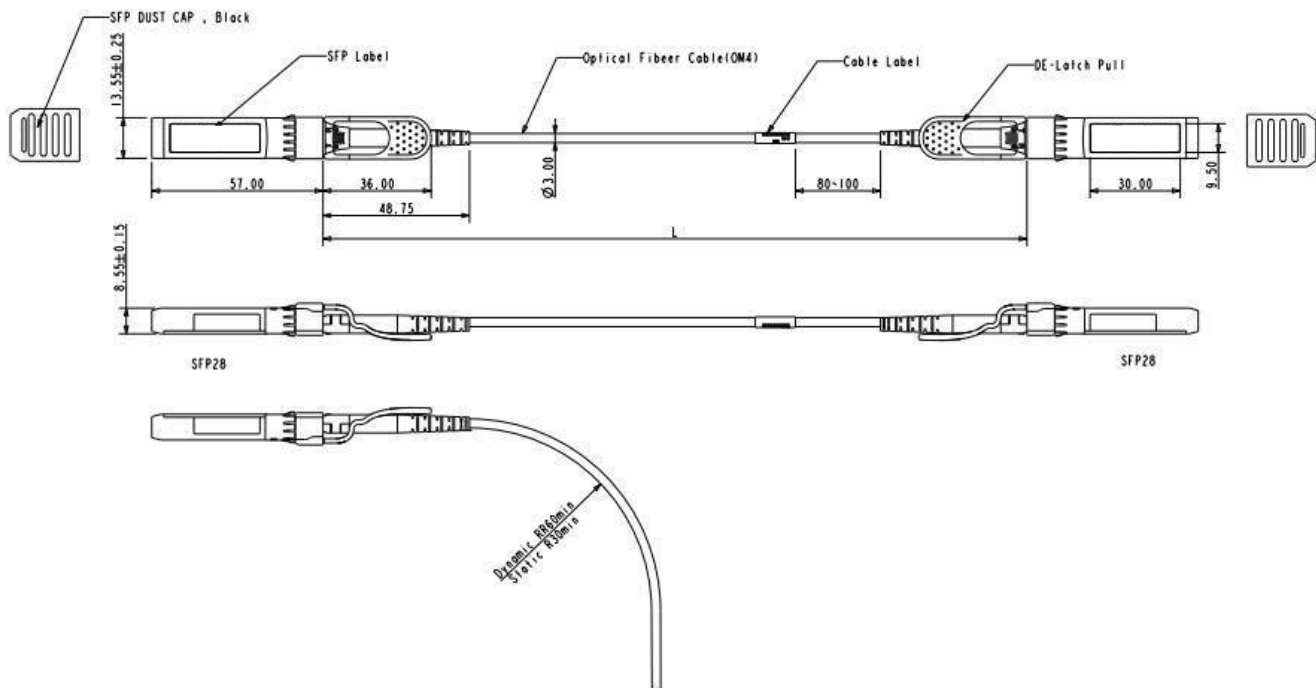

Ordering Information

Part Number	Model Number	Length (M)	Voltage	Temperature
ASF28-F-20-AK	Active Optical Cable	20	3.3V	0°C to 70°C

Note: All information contained in this document is subject to change without notice.