

Alpha Bridge AQSFP-F-07-AK Datasheet



Features

- 4 independent full-duplex channels
- Up to 11.2Gb/s data rate per channel
-
- QSFP+ MSA compliant
- Up to 100m transmission
- Operating case temperature: 0 to 70°C
- Single 3.3V power supply
- Maximum power consumption 1.5W each terminal
- RoHS-6 compliant

Application

- 10/40G Ethernet
- Infiniband SDR/DDR/QDR
- 2/4/8G Fiber Channel

Absolute Maximum Ratings

Parameter	Symbol	Min.	Max.	Units	Note
Storage Temperature	<i>T_S</i>	-40	85	°C	
Operating Case Temperature	<i>T_{op}</i>	0	70	°C	
Power Supply Voltage	<i>V_{cc}</i>	-0.5	3.6	V	
Relative Humidity (non-condensation)	<i>RH</i>	0	85	%	

Recommended Operating Conditions

Parameter	Symbol	Min.	Typical	Max.	Units	Note
Operating Case Temperature	<i>T_{op}</i>	0		70	°C	
Power Supply Voltage	<i>V_{cc}</i>	3.135	3.3	3.465	V	
Data Rate, each Lane			10.3125	11.2	Gb/s	
Control Input Voltage High		2		<i>V_{cc}</i>	V	
Control Input Voltage Low		0		0.8	V	

AOC Block Diagram

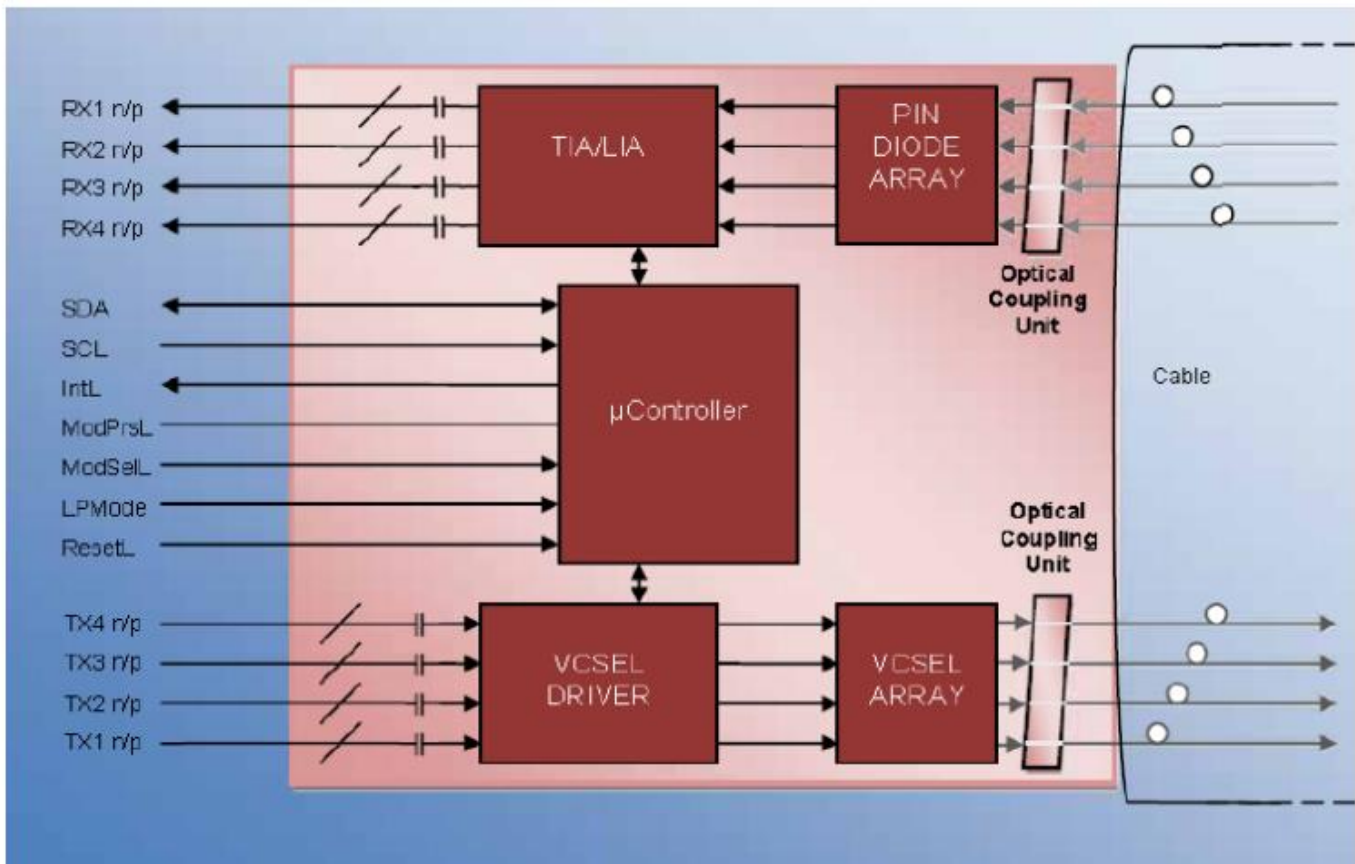

Block Diagram of One of the QSFP+ End Modules

Electrical Characteristics-Transmitter (each Lane)

Parameter	Symbol	Min	Typical	Max	Units	Notes
Power Consumption, each Terminal				1.5	W	
Supply Current, each Terminal	I _{cc}			450	mA	
Transceiver Power-on Initialization Time				2000	ms	
Single Ended Input Voltage Tolerance		-0.3		4	V	
AC Common Mode Input Voltage Tolerance		15			mV	RMS
Differential Input Voltage Swing Threshold		50			mV _{pp}	LOSA Threshold
Differential Input Voltage Swing	V _{in,pp}	180		1200	mV _{pp}	
Differential Input Impedance	Z _{in}	90	100	110	Ohm	
Differential Input S-parameter	SDD11	$< -12 + 2 \times \text{SQRT}(f)$, with f in GHz.			dB	0.01-4.1GHz
		$< -6.3 + 13 \times \log_{10}(f/5.5)$, with f in GHz			dB	4.1-11.1GHz
Reflected Differential to Common Mode Conversion	SCD11			-10	dB	0.01- 11.1GHz
Total Jitter				0.4	UI	
Deterministic Jitter				0.15	UI	

Electrical Characteristics-Receiver (each Lane)

Parameter	Symbol	Min	Typical	Max	Units	Notes
Single Ended Output Voltage		-0.3		4	V	
AC Common Mode Output Voltage				7.5	mV	RMS
Differential Output Voltage Swing	Vout,pp	600		800	mVpp	
Differential Output Impedance	Zout	90	100	110	Ohm	
Differential Output S- parameter	SDD22	$< -12 + 2 \times \text{SQRT}(f)$, with f in GHz			dB	0.01-4.1GHz
		$< -6.3 + 13 \times \log_{10}(f/5.5)$, with f in GHz			dB	4.1-11.1GHz
Common Mode Output Reflection Coefficient	SDD22	$< -7 + 1.6 \times f$, with f in GHz			dB	0.01-2.5GHz
				-3	dB	2.5-11.1GHz
Total Jitter				0.38	UI	In the case the specs of Tx jitters are met
Deterministic Jitter				0.64	UI	

Pin Assignment

QSFP Module Pad Layout (Top View)

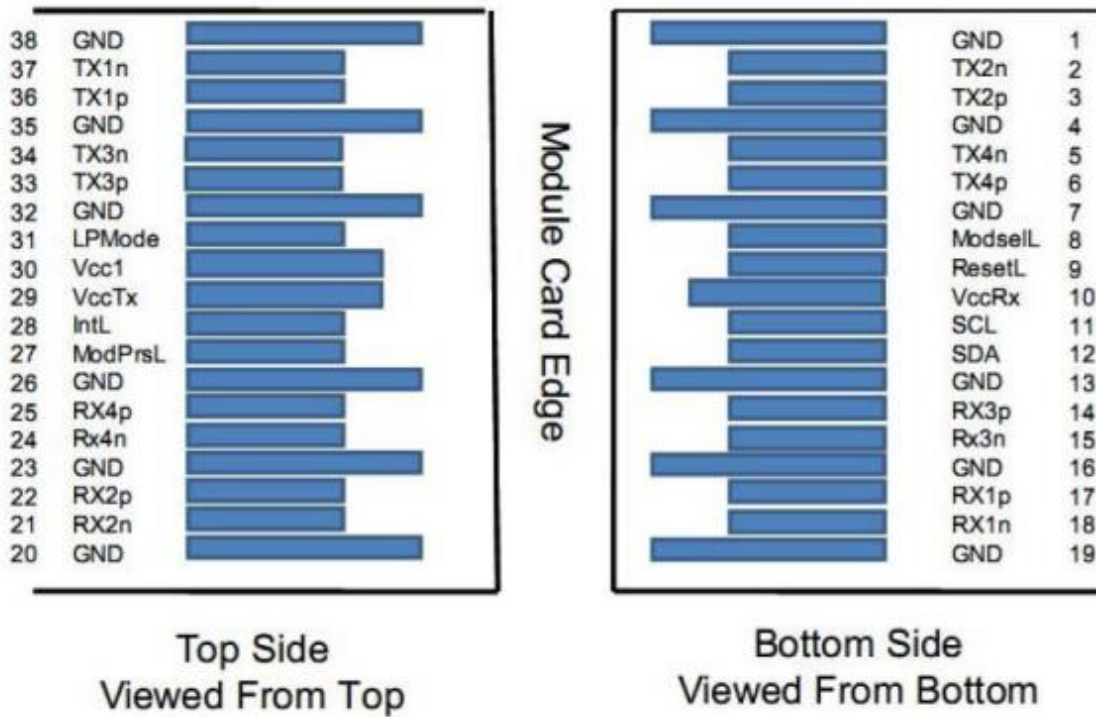

Pin Definition

Pin	Logic	Symbol	Description	Notes
1		GND	Ground	1
2	CML-I	Tx2n	Transmitter Inverted Data Input	
3	CML-I	Tx2p	Transmitter Non-inverted Data Input	
4		GND	Ground	1
5	CML-I	Tx4n	Transmitter Inverted Data Input	
6	CML-I	Tx4p	Transmitter Non-inverted Data Input	
7		GND	Ground	1
8	LVTTTL-I	ModSelL	Module Select	
9	LVTTTL-I	ResetL	Module Reset	
10		VccRx	+3.3V Power Supply Receiver	2
11	LVCMOS-I/O	SCL	2-Wire Serial Interface Clock	
12	LVCMOS-I/O	SDA	2-Wire Serial Interface Data	
13		GND	Ground	
14	CML-O	Rx3p	Receiver Non-Inverted Data Output	
15	CML-O	Rx3n	Receiver Inverted Data Output	
16		GND	Ground	1
17	CML-O	Rx1p	Receiver Non-Inverted Data Output	
18	CML-O	Rx1n	Receiver Inverted Data Output	
19		GND	Ground	1
20		GND	Ground	1
21	CML-O	Rx2n	Receiver Inverted Data Output	
22	CML-O	Rx2p	Receiver Non-Inverted Data Output	
23		GND	Ground	1
24	CML-O	Rx4n	Receiver Inverted Data Output	
25	CML-O	Rx4p	Receiver Non-Inverted Data Output	
26		GND	Ground	1
27	LVTTTL-O	ModPrsL	Module Present	
28	LVTTTL-O	IntL	Interrupt	
29		VccTx	+3.3V Power Supply Transmitter	2
30		Vcc1	+3.3V Power Supply	2
31	LVTTTL-1	LPMODE	Low Power Mode	
32		GND	Ground	1
33	CML-I	Tx3p	Transmitter Non-Inverted Data Input	
34	CML-I	Tx3n	Transmitter Inverted Data Input	
35		GND	Ground	1
36	CML-I	Tx1p	Transmitter Non-Inverted Data Input	

37	CML-I	Tx1n	Transmitter Inverted Data Input	
38		GND	Ground	1

- Note:
- GND is the symbol for signal and supply (power) common for QSFP+ modules. All are common within the QSFP+ module and all module voltages are referenced to this potential unless otherwise noted. Connect these directly to the host board signal common ground plane.
 - VccRx, Vcc1 and VccTx are the receiving and transmission power suppliers and shall be applied concurrently. Recommended host board power supply filtering is shown in Figure 3 below. Vcc Rx, Vcc1 and Vcc Tx may be internally connected within the QSFP+ transceiver module in any combination. The connector pins are each rated for a maximum current of 500mA.

Dimensions

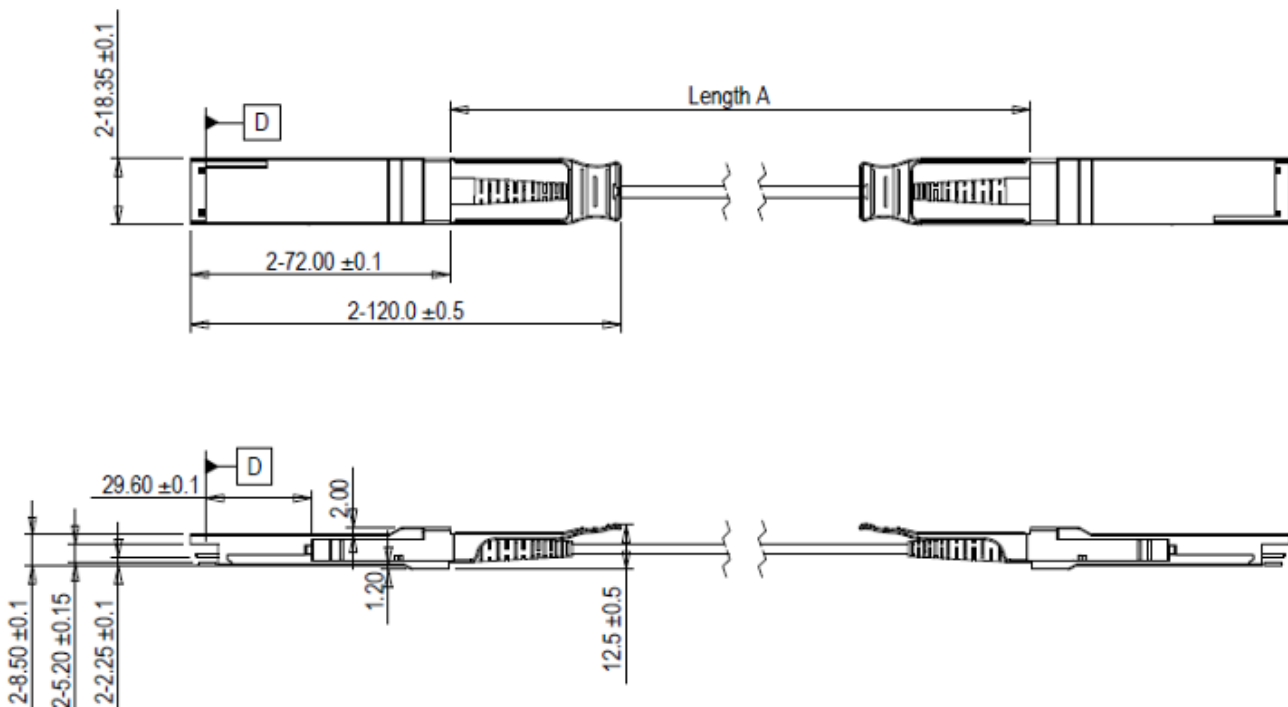

Ordering Information

Part Number	Model Number	Length (M)	Voltage	Temperature
AQSFP-F-07-AK	Active Optical Cable	3	3.3V	0°C to 70°C

Note: All information contained in this document is subject to change without notice.